

Technical Specification

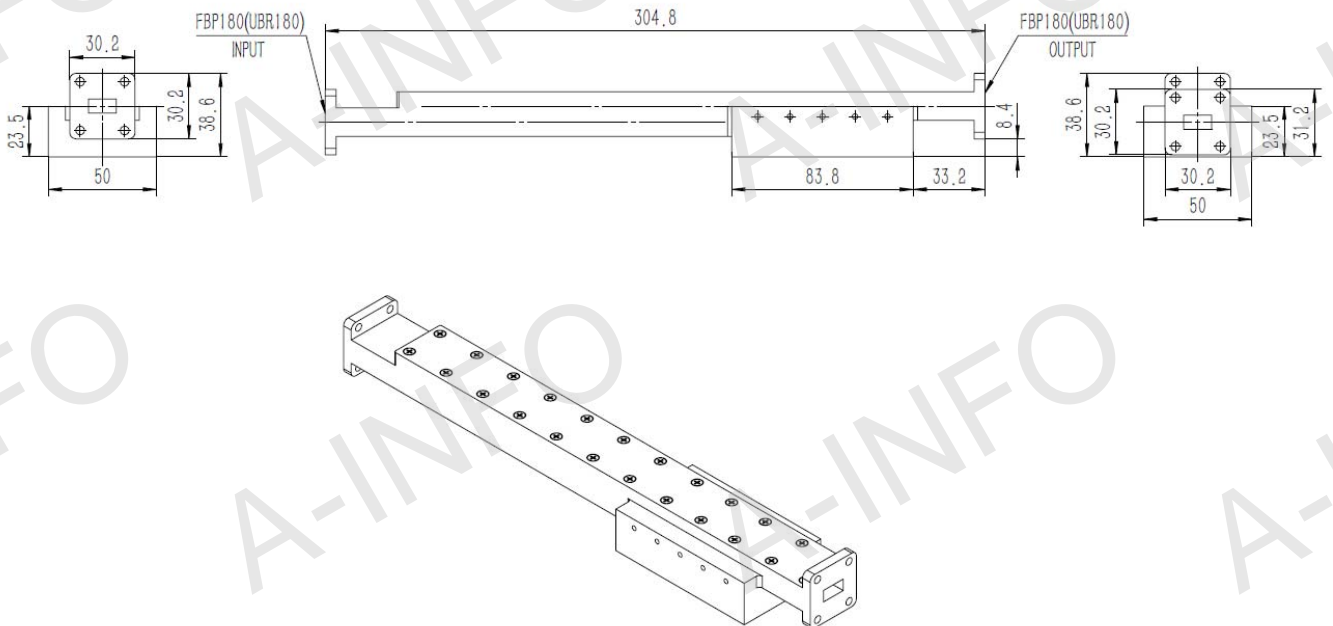

EIA WR	WR51
Frequency Range(GHz)	15.0-22.0
Attenuation(dB)	20
Attenuation Accuracy(dB)	±0.9 Max.
Attenuation Sensitivity(dB)	±0.7 Max.
VSWR	1.15:1 Max.
Average Power(W)	100 CW
Peak Power(KW)	120
Flange	FBP180(UBR180)
Material	Al
Size(mm)	304.8 x 50 x 38.6
Net Weight(Kg)	0.55 Around

Outline Drawing (Size: mm)



Flange Drawing (Size: mm)

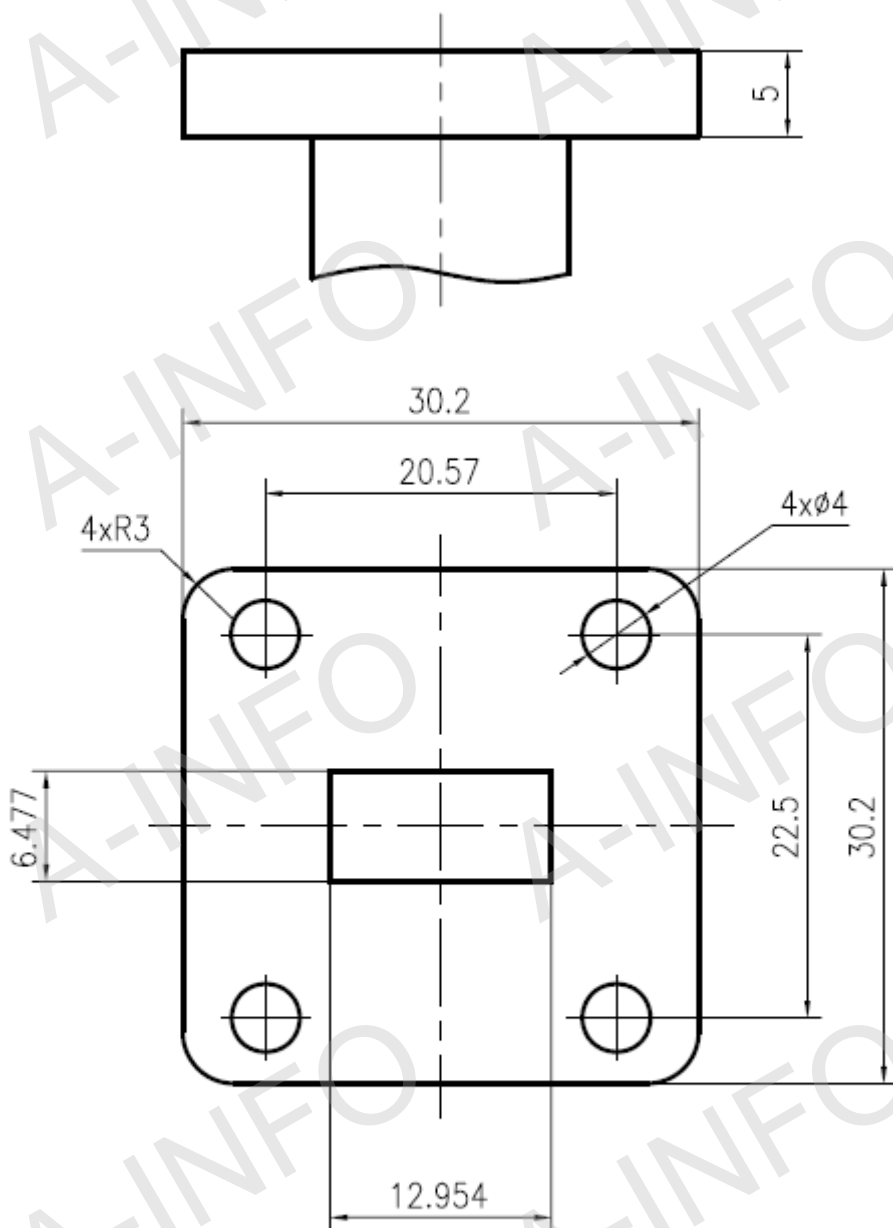

FBP180

AINFO Inc.

Page 2 of 3

China(Beijing):
China(Chengdu):
USA :

Tel: (+86) 10-6266-7326,
Tel: (+86) 28-8519-2786,
Tel: (+1) 949-639-9688,

(+86) 10-6266-7327
(+86) 28-8519-3044
(+1) 949-639-9608

Fax: (+86) 10-6266-7379
Fax: (+86) 28-8519-3068
Fax: (+1) 949-639-9670

Website: www.ainfoinc.com
Email: sales@ainfoinc.com

Test Result

Attenuation & VSWR

