

Technical Specification

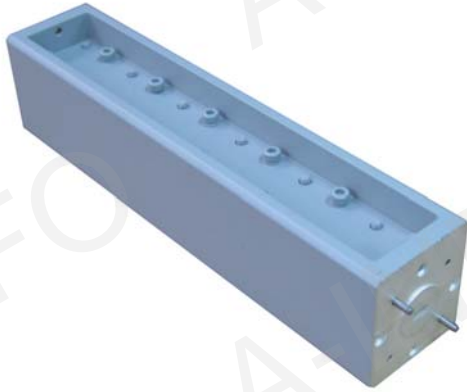

EIA WR	WR19
Frequency Range(GHz)	40.0 - 60.0
Attenuation(dB)	30
Attenuation Accuracy(dB)	±1.3 Max.
Attenuation Sensitivity(dB)	±0.9 Max.
VSWR	1.15:1 Max.
Average Power(W)	0.6 CW
Peak Power(KW)	0.3
Flange	FUGP500(UG-383/U-M)
Material	Cu
Size(mm)	139.7 x 28.6 x 31.7
Net Weight(Kg)	0.64 Around

Outline Drawing (Size: mm)

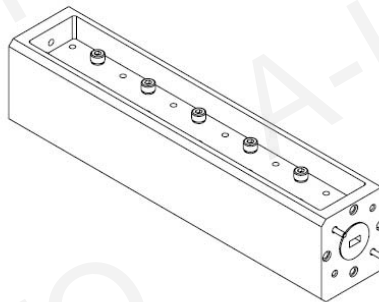
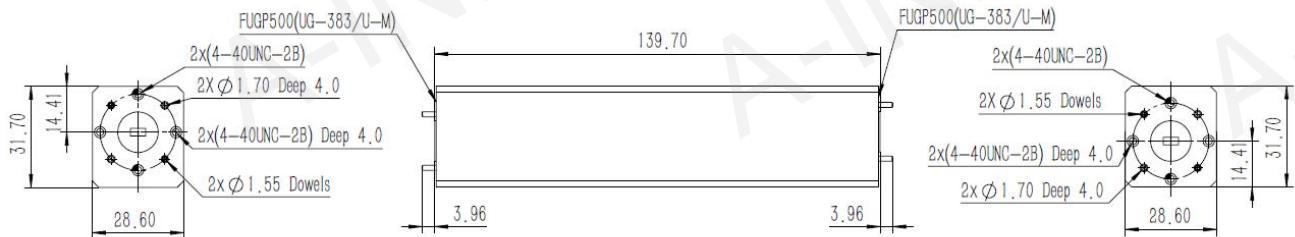

Flange Drawing (Size: mm)

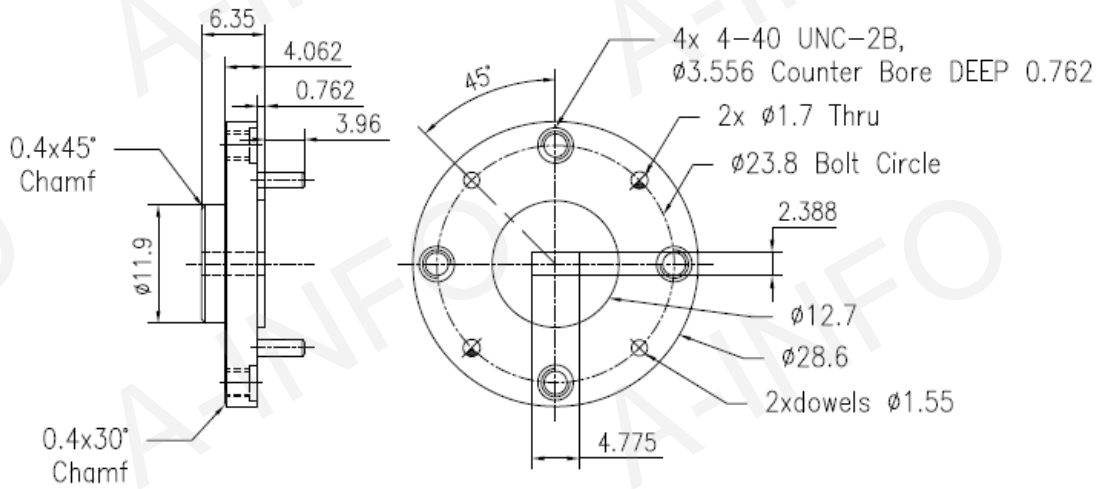

FUGP500
(equivalent to UG-383/U-M)

Test Results

Attenuation & VSWR

