

Technical Specification

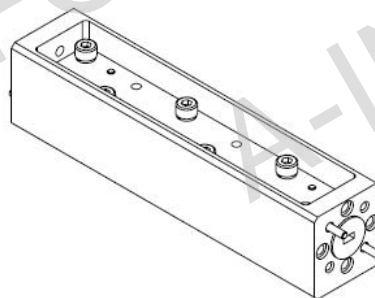

Frequency Range(GHz)	60.0-90.0
Waveguide	WR12
Attenuation(dB)	30
Attenuation Accuracy(dB)	±1.3 Max.
Attenuation Sensitivity(dB)	±0.9 Max.
VSWR	1.2 Max.
Average Power(W)	0.4 CW
Peak Power(KW)	0.03
Flange	FUGP740 (UG-387/U)
Material	Cu
Net Weight(Kg)	0.16 Around

Outline Drawing (Size: mm)

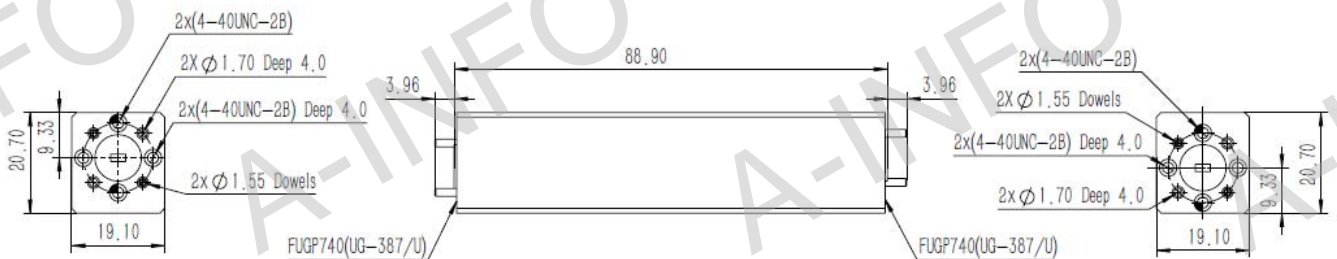

AINFO Inc.

Page 1 of 2

China(Beijing):
China(Chengdu):
USA :

Tel: (+86) 10-6266-7326,
Tel: (+86) 28-8519-2786,
Tel: (+1) 949-346-7326,

(+86) 10-6266-7327
(+86) 28-8519-3044
(+1) 949-639-9660

Fax: (+86) 10-6266-7379
Fax: (+86) 28-8519-3068
Fax: (+1) 949-639-9659

Website: www.ainfoinc.com
Email: sales@ainfoinc.com

Flange Drawing (Size: mm)

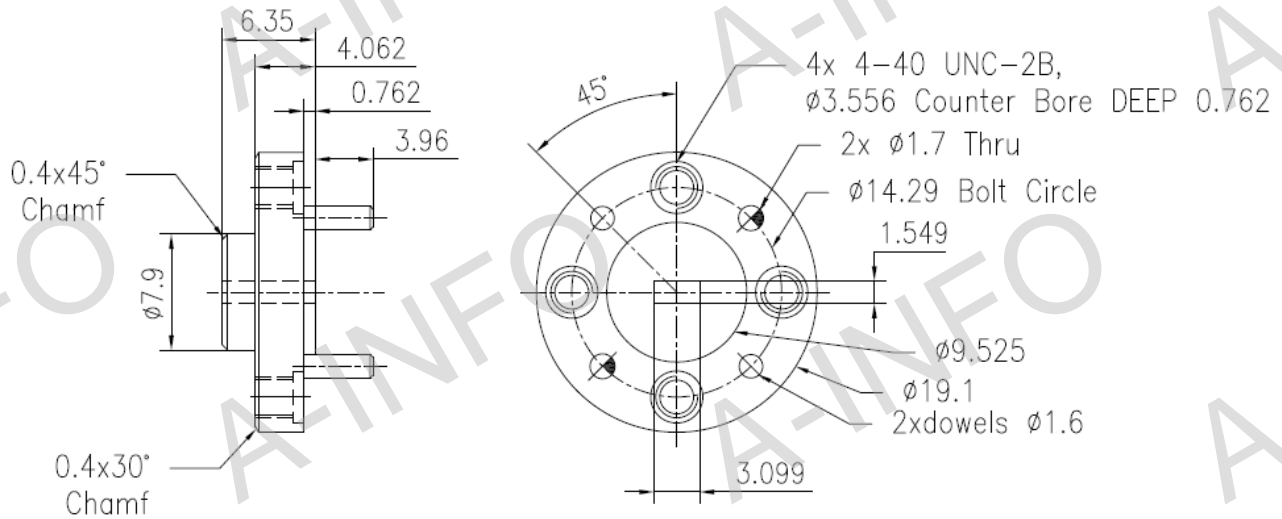

FUGP740
(equivalent to UG-387/U)

Test Results

